

GUIDE TO MAINTENANCE / PANDUAN PENJAGAAN

1. Before cleaning and maintaining, disconnect the electric supply for safety purposes.
Sebelum membuat sebarang pencucian dan penjagaan, keluarkan punca elektrik untuk keselamatan.
2. Use in dry place, free from excessive humidity and water.
Gunakan di tempat yang kering, bebas dari kelembapan udara dan air yang berlebihan.
3. Keep the fan clean.
Pastikan kipas di dalam keadaan yang bersih.
4. Handle blade with care during cleaning.
Jaga bilah kipas dengan teliti semasa pencucian.
5. Do not use gasoline or other chemical for cleaning.
Jangan gunakan minyak tanah atau bahan kimia untuk mencuci.

WIRING DIAGRAM / GAMBAR RAJAH PENDAWAIAN

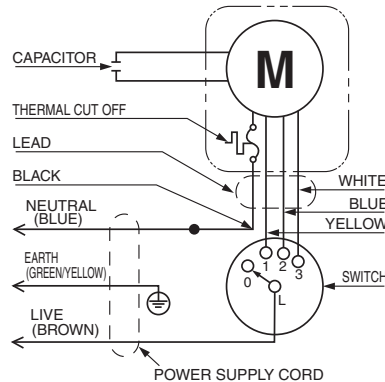

Panasonic Manufacturing Malaysia Berhad. (6100-K)

No. 3, Jalan Sesiku 15/2, Shah Alam Industrial Site,
40200 Shah Alam, Selangor Darul Ehsan.

Made in Malaysia



MN3048801EM

Panasonic®

TABLE FAN KIPAS MEJA

Model No. / Nombor Model
F-MN304
F-MN404

Operating Instructions Buku Panduan

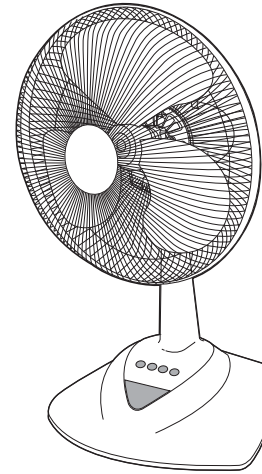

Before operating this product, please read the instructions carefully, and save this manual for future use.
Sebelum mengendalikan produk ini, sila baca arahan dengan teliti dan simpan manual ini untuk kegunaan pada masa akan datang.



Use only with rated voltage.
Guna hanya dengan voltan yang ditetapkan.



If the supply cord is damaged, it must be replaced by the manufacturer, its service agent or similarly qualified persons in order to avoid a hazard.
Sekiranya kabel bekalan kuasa rosak, ia mesti digantikan oleh pengilang atau agen servis atau seseorang yang berkecualan untuk mengelakkan bahaya.



Ensure that the fan is switched off from supply main before cleaning or maintenance.
Pastikan bekalan kuasa diputuskan sebelum pembersihan atau penyelenggaraan.



This appliance is not intended for use by persons (including children) with reduced physical, sensory or mental capabilities, or lack of experience and knowledge, unless they have been given supervision or instruction concerning use of the appliance by a person responsible for their safety.
Peralatan ini tidak direka untuk digunakan oleh individu (termasuk kanak-kanak) yang mempunyai kecacatan anggota, deria atau kebolehan mental, atau kurang pengalaman dan pengetahuan, melainkan mereka telah diberikan pemerhatian atau panduan mengenai penggunaan peralatan ini oleh individu yang bertanggungjawab mengenai keselamatan mereka.



To avoid the possibility of causing injury to users or damage properties, please follow all the explanation written below. The manufacturer is not responsible for accidents and injuries caused by defective or deficient installation.
Untuk mengelakkan kemungkinan berlaku kecederaan pengguna atau kerosakan harta benda, sila ikuti semua arahan yang dinyatakan. Pengilang tidak bertanggungjawab sekiranya berlaku kemalangan atau kecederaan yang disebabkan oleh kesilapan pemasangan.



Children should be supervised to ensure that they do not play with the appliance.
Kanak-kanak mestilah diberi pemerhatian untuk memastikan mereka tidak bermain dengan peralatan ini.

Thank you for purchasing this product.
Terima kasih kerana membeli produk ini.

*TO AVOID FAILURE, PLEASE ASSEMBLE ALL THE PARTS COMPLETELY BEFORE USING.
 * UNTOUK MENGELAKKAN KESILAPAN, SILA PASANGKAN SEMUA BAHAGIAN KIPAS SEBELUM MENGGUNA.

PART IDENTIFICATION / PENGENALAN BAHAGIAN KIPAS

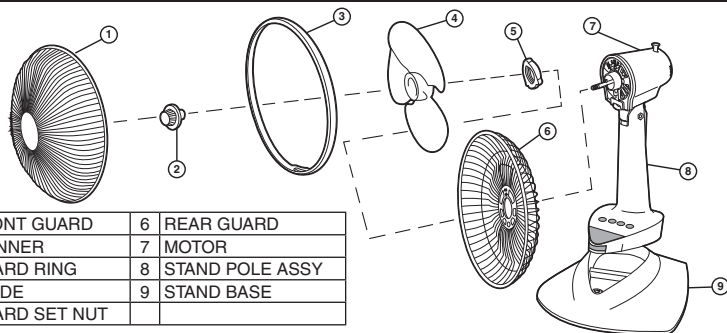

1 FRONT GUARD	6 REAR GUARD
2 SPINNER	7 MOTOR
3 GUARD RING	8 STAND POLE ASSY
4 BLADE	9 STAND BASE
5 GUARD SET NUT	

ASSEMBLY METHOD / CARA-CARA PEMASANGAN

1. Remove all the parts from the carton box.
1. Keluarkan semua barang dari dalam kotak.

2. Remove the P.V.C tube.
Remove the guard set nut by turning anti-clockwise.
2. Keluarkan tiub P.V.C.
Keluarkan "guard set nut" dengan cara pusing ke arah lawan jam.

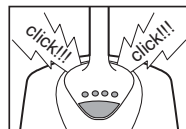
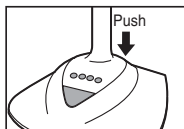
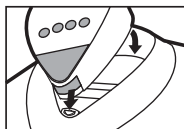
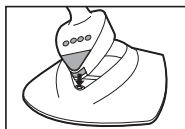
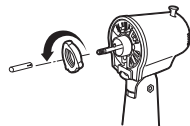

1. Match stand pole assembly to stand base.
1. Padankan "stand pole assembly" ke "stand base".

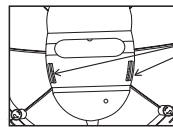

Stand Pole Nail
Stand Pole Rib

2. Fix the stand pole assembly according to the arrow direction until a click sound is heard.
2. Pasangkan "stand pole assembly" mengikut arah anak panah sehingga kedengaran bunyi "klik".
3. Make sure both of Stand Pole Nail to be fix inside the stand base hole firmly.
3. Pastikan kedua-dua Stand Pole Rib masuk ke dalam lubang stand base dengan sempurna.

View from bottom of stand base
Pandangan dari bawah stand base



F-MN304

F-MN404

4. Fix the rear guard into the motor guide (A).
4. Pasangkan "rear guard" mengikut tanda pandu (A).

5. Fasten the rear guard tightly by turning the guard set nut clockwise.
5. Pasang "rear guard" dengan mengetatkan "guard set nut" mengikut arah jam.

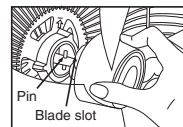

6. Insert the blade to the shaft and ensure the pin must enter the blade slot.
6. Masukkan "blade" pada "shaft" dan pastikan pin memasuki lurah "blade".

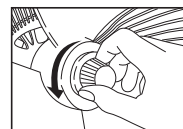

7. Tighten the blade using the spinner. Turn anti-clockwise.
7. Ketatkan "blade" dengan menggunakan "spinner". Pusingkan mengikut arah lawan jam sehingga ketat.

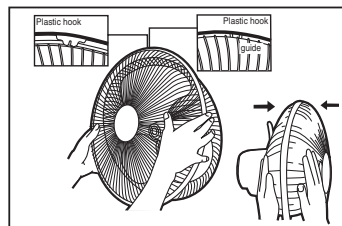

8. Fix the front guard with the logo in the upright position.
Fix the plastic hook onto the rear guard as shown.
8. Pasangkan "front guard" dan tentukan logo dalam kedudukan yang betul.
Pasangkan "plastic hook" ke arah "rear guard" seperti di gambar rajah.

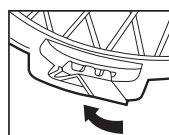

9. Press on the clip.
9. Tekan klip.

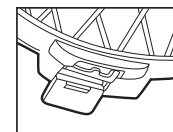

✘ Securely snap together the front and rear guards by pressing on the clip. Otherwise the front guard may fall off.
 ✘ Sila pastikan "front guard" dan "rear guard" terlekat dengan menekan klip pengunci. Jika tidak "front guard" akan jatuh.

TO DISMANTLED BASE AND POLE / CARA MEMBUKA BASE DAN POLE

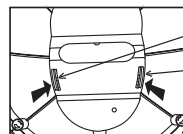

First Stand Pole Nail
Stand Pole Rib Pertama
Second Stand Pole Nail
Stand Pole Rib Kedua

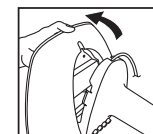

- * Push the First Stand Pole Nail and followed by the Second Stand Pole Nail.
* Tekan Stand Pole Rib Pertama dan diikuti dengan Stand Pole Rib Kedua.

- * Hold the Stand Pole and pull the base towards opposite direction.
* Pegang Stand Pole dan tarik stand base ke arah bertentangan.

SPECIFICATION / SPESIFIKASI

MODEL	VOLTAGE(V~) VOLTAN	FREQ.(Hz) FREKUENSI	POWER(W) KUASA	SPEED/KELAJUAN (RPM)			AIR VELO. m/min	AIR DEL. m ³ /min
				1	2	3		
F-MN304	240	50	39	875 ~ 1074	1053 ~ 1287	1123 ~ 1373	214	43
F-MN404	240	50	58	765 ~ 935	923 ~ 1128	1089 ~ 1331	250	84.6

Specification are subject to change without notice with the development of technology.
 Spesifikasi adalah tertakluk pada pertukaran tanpa notis selaras dengan perkembangan teknologi.